

The upper left corner of the furniture

The upper right corner of the furniture

SCALE 1:1

**! IMPORTANT!** The furniture carcass falls outside of the wall bracket fitting positions.

**TEMPLATE FOR HANGING FURNITURE**

- 1. Cut template along dotted line.
- 2. Fix the template with masking tape to the wall in correct installation position.

NOTE: Use a spirit level to the template is straight.

- 3. Drill holes using a suitable drill bit, marked . Further installation steps are in the manual supplied with product.

**Warning symbol**  
Please check for any hidden pipes or electrical cables before drilling holes in the floor or walls. When using power tools always follow the manufacturer's user guide. Ensure appropriate wall plugs (supplied) for solid or cavity are used

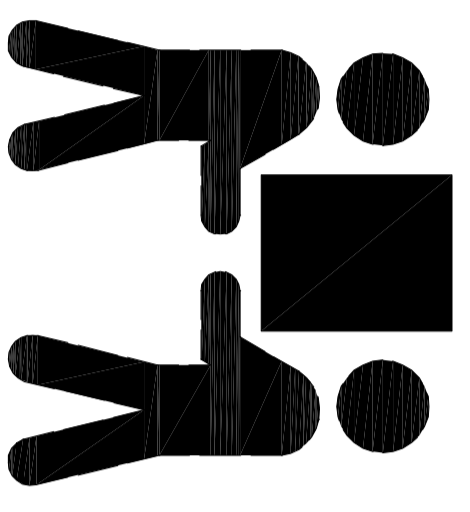

It is recommended that 2 persons carry out the installation of larger basin/vanity unit over 30Kgs gross weight

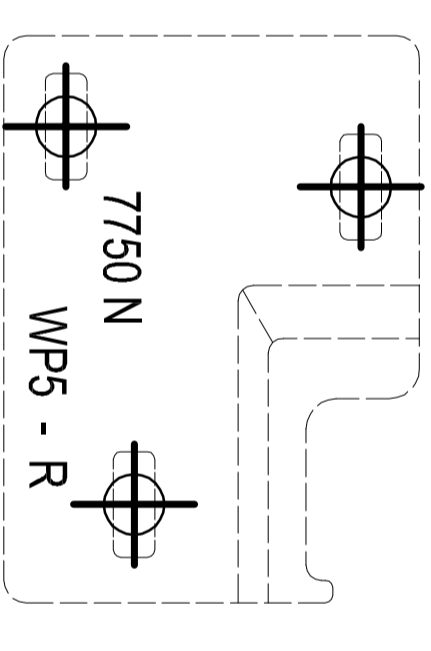
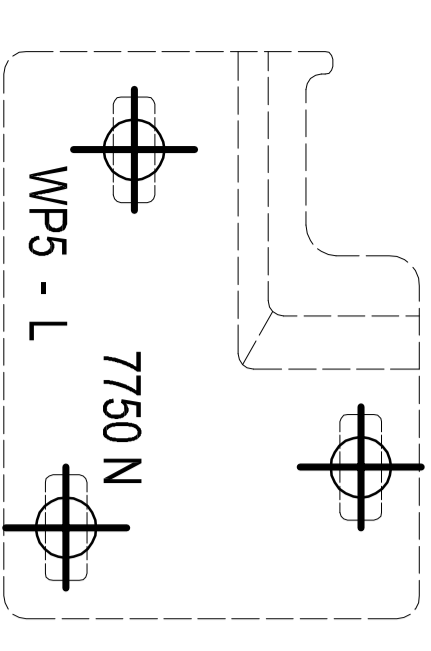









Individual product number:  
**Arena 700**  
Weight Kgs  
**24Kgs**

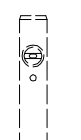

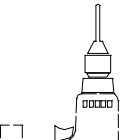
**MANUAL**

**Tools required**

- Scissors 
- Tape measure 
- Spirit level 
- Masking tape 
- Drill 
- Drill bit 8mm 
- Phillips No 2 Screwdriver 
- Clear silicone 

**Sealing with silicone**

Carefully apply silicone as shown below. Leave silicone to 24 hours to dry.

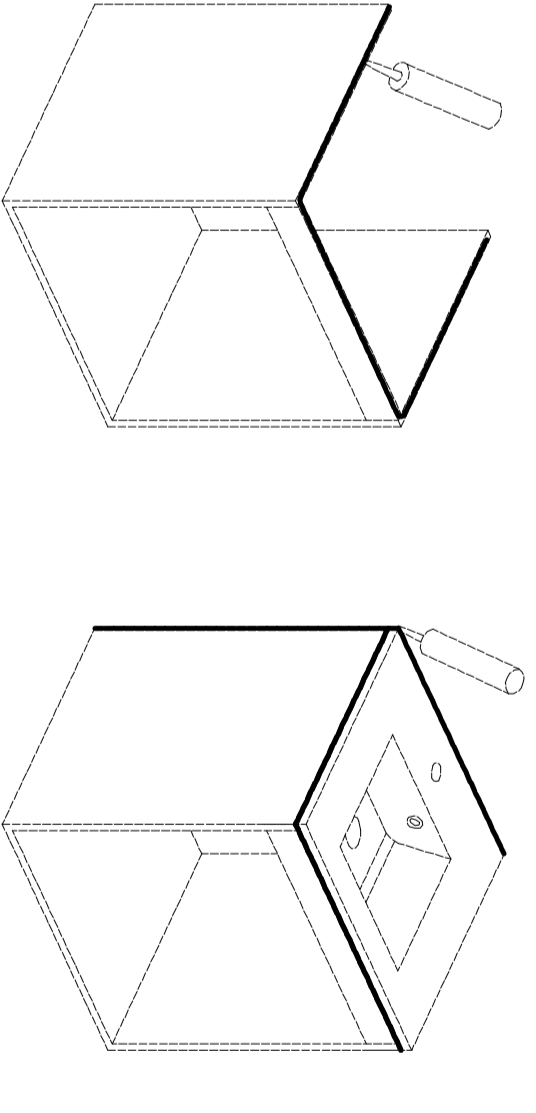

**CLEANING AND CARE INSTRUCTIONS FOR FURNITURE**

The finished boards and edging used for Crosswater moisture resistant furniture have highly durable finishes and are easy to clean surfaces.

**Light Sailing**

Clean the bathroom furniture with a soft clean cloth rockered in warm water and a little detergent. Do not use abrasive cleaners or hot steam. Rinse with clean water and dry. For stubborn stains use a damp cloth moistened in clean water to remove any soiling. Then rub with a damp cloth moistened in clean water to remove the cleaning agent and avoid stains or streaks. Remove stubborn soiling with hot water and a little mild detergent if necessary. Dry the surface with a clean, dry soft cloth.

**DO NOT USE:**  
ABRASIVE CLEANERS, SCOURING PADS, STEEL WOOL, etc.  
WAXES, POLISHES, FINISHES, WAXES, STAIN REMOVERS, etc.  
FINISHING POLISH  
WARNING:  
Avoid hot or sharp objects coming into contact with the furniture.

**IMPORTANT NOTE**  
You should carefully read the recommendations for use provided by your cleaning product manufacturers. If in doubt, you can test the cleaning agent and care product in an inconspicuous area.

**INSTALLTION OF WALL BRACKETS AND HANGERS**

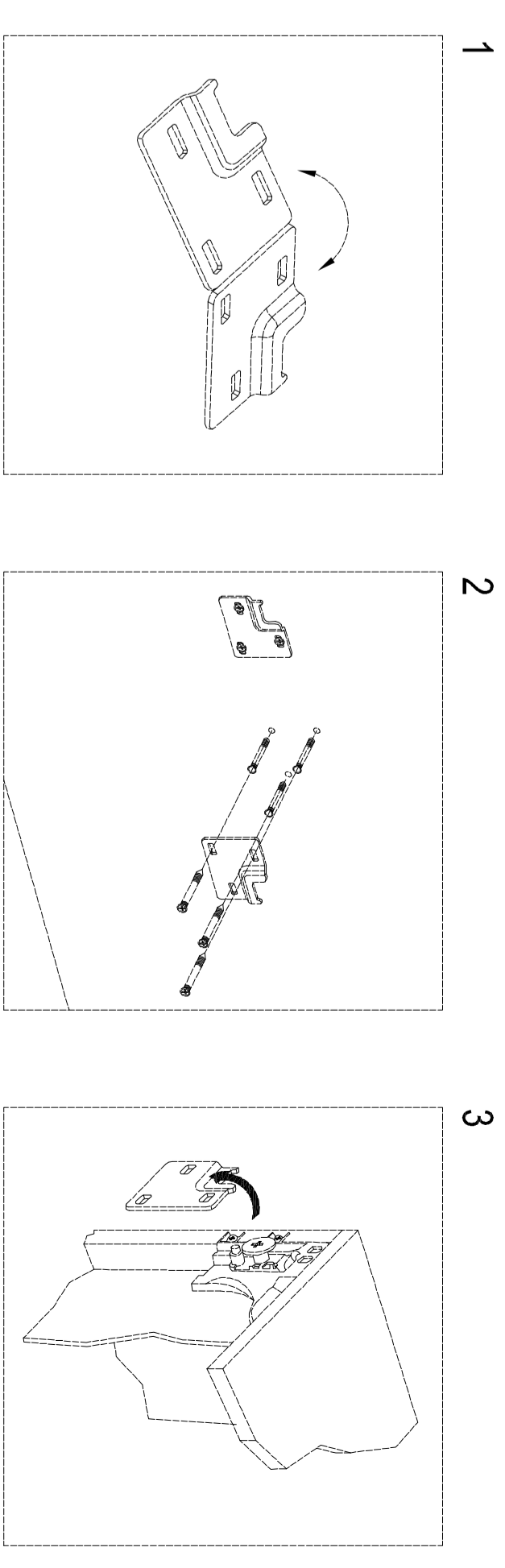

**IMPORTANT**  
Only use wall brackets supplied.  
The hanging kit supplied includes 8x x 40 screws and wall plugs for solid walls. Use correct wall plugs for cavity walls.



The mounting kit includes dowels size Ø8x40. Check whether they are suitable for your wall.

**Adjust hangers**

Hanger 7750N

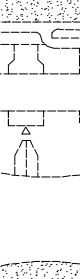
- 1 Height adjustment 13mm 
- 2 Depth adjustment 12mm 
- 3 Lock the cabinet on the wall 

Hanger 2750N

